

Terminal XMP-TMC2801-FP

Security, time and attendance

Purpose

The TMC2800 series readers convince because of its user friendly and easy handling. The beautiful, small and ergonomic designed housing fits excellent in every kind of building architecture.

The terminals TMC2800 are designed to connect to a door controller unit XMP-K32, XMP-K32sx or XMP-K12.

The connection between reader and door controller uses two wire pairs, whereby one pair provides the power supply and the other is used for data transfer.

Technical data

Fingerprint sensor:	Optical fingerprint sensor
Reader address:	Adjustable by micro switch
Tamper	Internal sabotage contact (reader stops working at sabotage)
Protection type:	IP 65
Power supply:	11-24 V (AC / DC) 5,5-8 VA
Interfaces:	2x RS 485 (2 wire) 9600-19200 Baud asynchronous (1x door controller, 1x reader head)
Processor:	M16C 16 Bit; 16 MHz; CMOS-Design
Memory:	32kB Flash Memory
Case:	Material ABS (impact proofed housing)
Color :	Silver
Protection class:	IP 65
Dimensions (LxWxH):	195 x 130 x 80 mm
Weight:	Approx. 0,54 kg
Environmental conditions:	From 0°C to +70°C (operation and storage) int. heating possible

Possible protocols

BPA/9plus (K32/K32sx firmware V3.4, BD 07/07/08), and SecuCrypt® (K32/K32Lite firmware V3.4, BD 07/07/08)

Booking times with fingerprint

2 sec. plus response time of K32/K32L (see K32/K32sx documentation). Up to 100.000 fingerprints per K32/K32sx.



XMP-TMC2801-FP

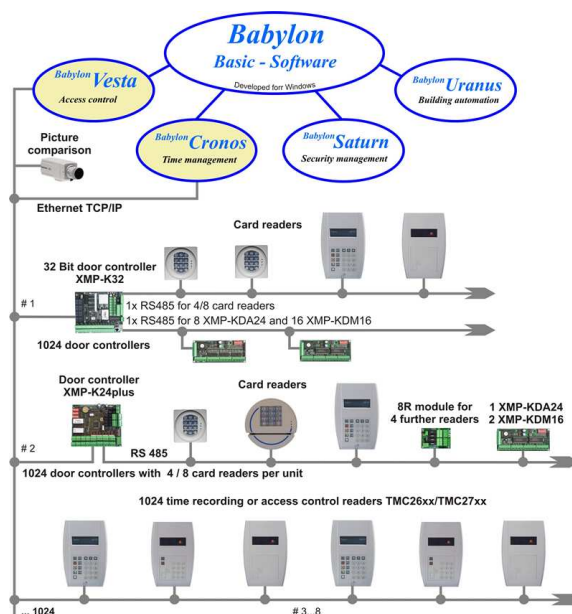

Scheme for the connection possibilities of card readers to BABYLON

Legend

Access controller K12, K32sx, K32:

Door controller unit with RS485 interface. Each XMP-K32(sx)-000 and XMP-K32(sx)-050 it is possible to connect 8 access and time recording terminals.

Order No:

XMP-TMC2801- HIT/MIF/LEG

Access control terminal without keyboard, LED-Display, fingerprint sensor and reader head

Highlights:

- **Status display** with LEDs for the situation of the door opening relay and reader communication.
- **End resistance** for low interrupted data transmission, integrated in the reader and individual configuration possible.
- **Reader addresses** adjustable by dip-switch. All switches can be changed while reader is running.
- **Firmware update** from Host. (using SecuCrypt® protocol)
- **Integrated Sabotage tamper** reader stops working at sabotage.
- **Protocol encryption** selectable with micro switch. (BPA/9 plus, plain / SecuCrypt® 192 blowfish encrypted)
- **Supports ASCII badge numbers**
- **High quality encrypted communication** between card reader and door controller. (SecuCrypt®)
- **Impact proved housing**
- **Indoor / Outdoor** sensor calibration
- **Access on card AOC**
- **Fingerprint on card FOC**
- **FAR: False Acceptance Rate:**
< 0.0001%
- **FRR: False Rejection Rate:**
< 0.1%

Fields of application

- Access control
- Time recording
- Time and attendance
- Door management
- Parking Systems
- Elevator control

The fingerprint option is also available in connection with terminal types:

- XMP-TMC2802-FP-MIF/LEG/HIT
- XMP-TMC2852-FP

Mounting instructions

The XMP-TMC-2801 reader is designed to be wall mounted to internal walls. The wall must have sufficient load-bearing capacity.

Suitable wall structures are as follows:

- Concrete walls
- Plastered brick walls
- Plasterboard walls (use special attachment systems)
- Ensure that the area is dry, clear of dust and, where applicable, sufficient accessible.

Wiring to the door controller

For the installation of an XMP-TMC2801 reader to a door controller, please refer also to the instruction manual

Part. No. : IMXMP-K32lite/K32
delivered with the required door controller XMP-K32 or XMP-K32lite.

Door messages and the activation of the door opener should not pass through a bus cable.

Depending on the door monitoring model, this requires cables with 4 or 5 (6) pairs of wires from door controller to the controlled door.

Setting the readers parameters

The user has the option of significantly influencing the control behavior of the XMP-TMC2801 reader. Please refer also to the instruction manual

Part. No.: UMXMP-K32lite/K32
delivered with the required door controller XMP-K32 or XMP-K32lite.

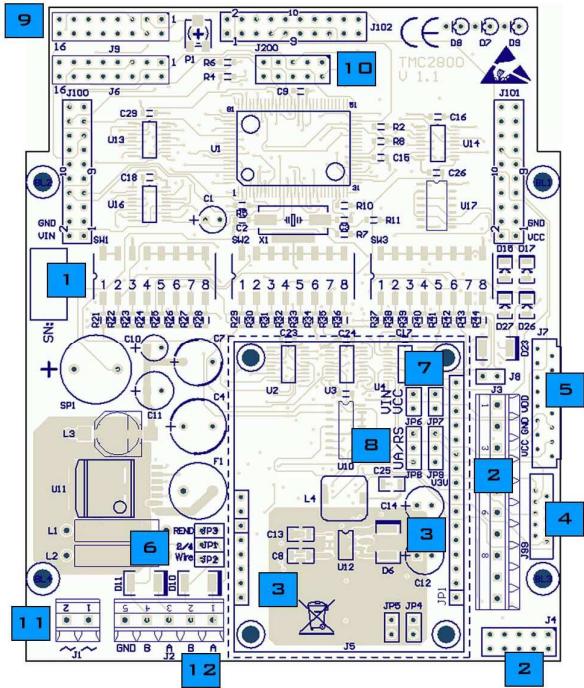

1. Dipswitch block SW1 to SW3
2. Interface reader head
3. Interface for fingerprint sensor
4. Connection to standard keyboard
5. Connection to sensor keyboard / reader head
6. Jumper block JP1 to JP3
 2/4 Wire = reader interface (open = 4 wire)
 2/4 Wire = reader interface (close = 2 wire)
 2/4 Wire = reader interface (open = 4 wire)
 2/4 Wire = reader interface (close = 2 wire)
 REND = reader interface end resistance
7. Power supply 12-24V DC for reader head
8. Interface for reader head (2) UART / RS485
9. Connection to Fluorescent Display
10. Interface for flashing firmware
11. Power supply 12-24V AC/DC
12. RS485 interface (door controller)

Scheme for the connection of the reader to the XMP-K32 / XMP-K32sx / K12

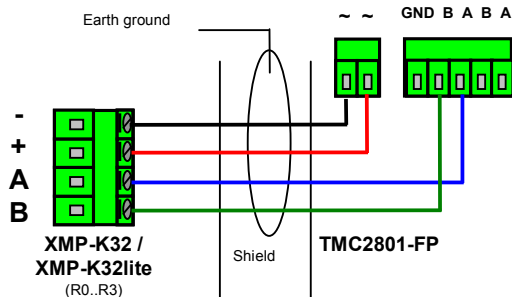

Dipswitch blocks SW1 to SW3

1. Adjusting the reader address

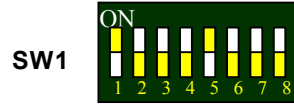

SW1 : switch 1 to 3

Switcher	1	2	3
Address 0	off	off	off
Address 1	on	off	off
Address 7	on	on	on

Addresses adjustable from 0 up to 7

SW1 : switch 5

Protocol type:
ON = SecuCrypt, OFF = BPA9 plus

SW1 : switch 6

ON = Sensor keypad

SW1 : switch 7

OFF = Deister reader head
ON = Barcode reader

SW1 : switch 8

ON = Boot loader activated

2. Special functions switch block SW 2

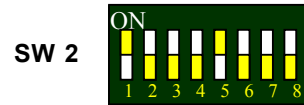

SW2 : switch 1

Fingerprint On Card activated

SW2 : switch 6

Adjusting the Baud rate between door controller and reader using the RS485 Bus (9600 = off and 19200 = on).

3. Switch block SW 3

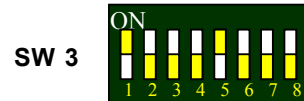

SW3 : switch 3 and 4

ON = Identification only by fingerprint sensor.

OFF = Verification (fingerprint and badge/Pin)

SW3 : switch 6

ON = 8 Bit protocol, when using BPA9 plus.
OFF = 7 Bit protocol, when using BPA9 plus.

Add on instruction for the TMC2800 heater

For additional heating, the following parts are needed:

- XMP-TMC2500-NT-12V-BG (Order - NR.)
- XMP-TMC2500-HZ (Order - NR.)

The heater metal can be put on the power pack housing (see picture).

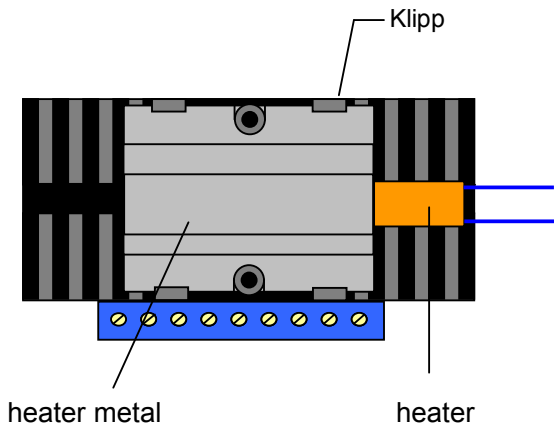

1. Input:

AC = 85 Volt – 264 Volt (50Hz)
 DC = 110 Volt – 370 Volt (Polarity any way)

At the connections plus and minus an output voltage is spent by 12V/0,9A (peak 1,08A, ca.12 Watt).

The power input is depending upon outside temperature between 300 mA (3.6 Watts) and 500 mA (6 Watt).

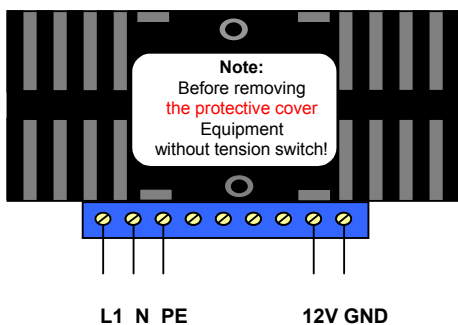

At the ports L, N and PE the mains voltage is attached. Please only of an authorized specialist to accomplish leave.

2. Technical data

TMC2500-NT-12V-BG

- 10.8 Watts
- 12 V
- 0.9 ampere
- VDE - Permissions: UL1950, C-UL, EN60950, VDE0160 according to DEN-AN and IEC60950

3. Effective range of contact less read heads

The reader head is placed with in the characterized position under the TMC2801-FP - reader front. Within this position, badges have maximum read distance.



This symbol marks proximity reader head.

Important customer information!

Defective circuit boards must be disposed professionally. Batteries and accumulators must be disposed as hazardous waste. The package can be used again or must be disposed. The green filling material can be disposed as bio waste.

